



TC-Series Circulating Baths with MX Temperature Controller

Operator's Manual



Models:

TC-150MX
TC-250MX
TC-450MX
TC-550MX
TC-650MX
TC-950MX



Table of Contents

Introduction	2
Brookfield Circulating Baths with MX Temperature Controller	2
Performance Specifications	3
General Safety Information	4
Safety Recommendations	5
Regulatory Compliance and Testing	6
Unpacking Your Circulator	6
Package Contents	7
Controls and Components	8
Quick-Start	11
Installation and Startup	13
General Site Requirements	13
Adding Liquid to the Bath Reservoir	13
External Closed Loop Circulation	14
Refrigeration Control Connections (Refrigerating/Heating Circulators only)	15
Electrical Power	16
Controller Setup	17
Power	17
Safety Set Temperature	17
Normal Operation	18
Keys and Controls	18
Turning Your Circulator ON	18
Main Operational Display	18
Set-Up Sub-Menus	19
Adjusting the Temperature Set Point	19
Selecting the Temperature Unit	20
Setting the Offset Calibration	21
Setting the Low Limit Temperature	22
Setting the High Limit Temperature	23
Adjusting the Auto Cool Temperature	24
Resetting the Factory Default Values	25
Loss of Power Restart	25
Display Messages and Alarms	26
Routine Maintenance and Troubleshooting	27
Maintaining Clear Bath Water	27
Draining the Bath Reservoir	27
Checking the Over-Temperature Safety System	28
Cleaning Your Circulator	29
Temperature Controller	29
Bath Reservoir	29
Condenser, Air Vents, and Reusable Filter (Refrigerated Models only)	29
Temperature Controller Removal and Re-Installation	30
Troubleshooting Chart	32
Technical Information	34
Reservoir Fluids	34
Application Notes	35
Equipment Disposal (WEEE Directive)	36
Replacement Parts, Optional Accessories & Fluids	37
Warranty Repair and Service	38

Introduction

Thank you for choosing a Brookfield Circulating Bath with MX Temperature Controller. It is intended for the precise temperature control of suitable liquids in a reservoir. Extremely easy to use and maintain, it combines design innovation with highly intuitive operation to deliver convenient and versatile liquid temperature control for a wide range of applications.

	<p>WARNING: Brookfield Circulating Baths are not intended for directly controlling the temperature of foods, pharmaceuticals, medicines, or other objects which may be ingested by or injected in humans or animals. Any such objects must be isolated from contact with the bath fluid and bath surfaces.</p>
-----------------------------------------------------------------------------------	-----------------------------------------------------------------------------------------------------------------------------------------------------------------------------------------------------------------------------------------------------------------------------------------------------------------------

Here are some of the features that make your Circulating Bath so user-friendly:

- Simple, intuitive operation
- Displays actual and set point temperature simultaneously
- Powerful pump, easy flow adjustment
- External circulation capability
- Fully enclosed housing prevents direct contact with pump and heater, yet provides quick access for inspection and cleaning
- Suitable for use with Class I non-flammable fluids per DIN 12876-1

It will take you very little time to get your new Circulating Bath installed and running. This Operator's Manual is designed to guide you quickly through the process. We recommend that you read it thoroughly before you begin.

Brookfield Circulating Baths with MX Temperature Controller

Model Type	Reservoir Capacity	Temperature Range	
		°C	°F
TC-150MX Heat only Circulator *	6 liters	Ambient +10°C to 135°C	Ambient +20° to 275°F
TC-250MX Heat only Circulator *	10 liters	Ambient +10°C to 135°C	Ambient +20° to 275°F
TC-450MX Heat only Circulator	28 liters	Ambient +10°C to 135°C	Ambient +20° to 275°F
TC-550MX Refrigerating/Heating Circulator	7 liters	-20° to 135°C	-4° to 275°F
TC-650MX Refrigerating/Heating Circulator	7 liters	-20° to 135°C	-4° to 275°F
TC-950MX Refrigerating/Heating Circulator	15 liters	-30° to 135°C	-22° to 275°F

*. Compatible with optional TC-351 Chiller for low temperature operation to -15°C (5°F).

Performance Specifications

Operating Temperature Range:	Model dependent; see table below	
Temperature Stability:	±0.07C (±0.13°F)	
Pump Type:	1-speed pressure	
	<u>60Hz models</u>	<u>50Hz models</u>
Maximum Pressure:	2.3 psi (0.16 bar)	1.8 psi (0.12 bar)
Maximum Pressure Flow Rate:	3.6 gpm (13.5 lpm)	3.1 gpm (11.9 lpm)
Heater Wattage:	1100 watts	1100 watts

Model Type	Reservoir Capacity	Internal Working Area (L x W x D)	Overall Dimensions (L x W x H)	Gross Weight	Temperature Range
TC-150MX Heated Circulator	6 liters	4.5 x 4.0 x 6.0 in. 11.4 x 10.2 x 15.2 cm	13.4 x 8.1 x 16.0 in. 34.0 x 20.6 x 40.6 cm	20 lbs. 9.1 kg	Ambient +10° to 135°C Ambient +20° to 275°F
TC-250MX Heated Circulator	10 liters	5.0 x 11.0 x 6.0 in. 12.7 x 27.9 x 15.2 cm	13.9 x 13.5 x 16.0 in. 35.3 x 34.3 x 40.6 cm	39 lbs. 17.7 kg	Ambient +10° to 135°C Ambient +20° to 275°F
TC-450MX Heated Circulator	28 liters	12.1 x 10.4 x 8.0 in. 30.7 x 26.4 x 20.3 cm	20.9 x 13.5 x 18.0 in. 53.1 x 34.3 x 45.7 cm	66 lbs. 29.9 kg	Ambient +10° to 135°C Ambient +20° to 275°F
TC-550MX Refrigerating/Heating Circulator	7 liters	6.18 x 5.59 x 5.0 in. 15.7 x 14.2 x 12.7 cm	23.2 x 16.2 x 17.3 in. 58.9 x 41.1 x 43.9 cm	84 lbs. 38.1 kg	-20° to 135°C -4° to 275°F
TC-650MX Refrigerating/Heating Circulator	7 liters	6.18 x 5.59 x 5.1 in. 15.7 x 14.2 x 12.9 cm	21.3 x 8.7 x 25.4 in. 54.1 x 22.1 x 64.5 cm	84 lbs. 38.1 kg	-20° to 135°C -4° to 275°F
TC-950MX Refrigerating/Heating Circulator	15 liters	8.35 x 10.88 x 5.5 in. 21.2 x 27.6 x 14.0 cm	22.4 x 14.5 x 28.0 in. 56.9 x 36.8 x 71.1 cm	112 lbs. 50.8 kg	-30° to 135°C -22° to 275°F

Model Type	Electrical Requirements **		
	120V Units	240V Units	100V Units
TC-150MX Heated Circulator	120V, 60Hz, 10A	240V, 50Hz, 6A	100V, 60Hz, 10A
TC-250MX Heated Circulator	120V, 60Hz, 10A	240V, 50Hz, 6A	100V, 60Hz, 10A
TC-450MX Heated Circulator	120V, 60Hz, 10A	240V, 50Hz, 6A	N/A
TC-550MX Refrigerating/Heating Circulator	120V, 60Hz, 12A	240V, 50Hz, 8A	100V, 60Hz, 12A
TC-650MX Refrigerating/Heating Circulator	120V, 60Hz, 12A	240V, 50Hz, 8A	100V, 60Hz, 12A
TC-950MX Refrigerating/Heating Circulator	120V, 60Hz, 13A	240V, 50Hz, 10A	N/A









** Voltage Utilization Range: +/- 10% from Listed Nominal Voltage

Environmental Conditions	Indoor use only
	Maximum Altitude: 2000 meter
	Operating Ambient: 5° to 35°C (41° to 95°F)
	Relative Humidity: 80%, non-condensing
	Installation Category: II
	Pollution Degree: 2
	Ingress Protection: IP 31
	Climate Class: SN
	Software Class: B
	Output Waveform: Sinusoidal

Specifications subject to change without notice.

General Safety Information





When installed, operated, and maintained according to the directions in this manual and common safety procedures, your Circulating Bath should provide safe and reliable temperature control. Please ensure that all individuals involved in the installation, operation, or maintenance of this Circulating Bath read this manual thoroughly prior to working with the unit.

	This symbol alerts you to a wide range of potential dangers.
	This symbol advises danger from electricity or electric shock.
	This symbol indicates that a hot surface may be present.
	This symbol marks information that is particularly important.
	This symbol indicates alternating current.
	These symbols on the Power Switch / Circuit Breaker indicate that they place the main power supply ON / OFF.
	This symbol on the Power Key indicates that it places the unit in a standby mode. It DOES NOT fully disconnect the unit from the power supply.
	This symbol indicates a protective conductor terminal.

**Read all instructions pertaining to safety, set-up, operation, and maintenance.
Proper operation is the user's responsibility.**

Safety Recommendations

To prevent injury to personnel and/or damage to property, always follow your workplace's safety procedures when operating this equipment. You should also comply with the following safety recommendations:

	<p>WARNING:</p> <ul style="list-style-type: none">• This Circulating Bath is suitable only for use with Class I non-flammable fluids (per DIN 12876-1).• Be aware of the chemical hazards that may be associated with the bath fluid used. Observe all safety warnings for the fluids used as well as those contained in the material safety data sheet.• Use only recommended bath fluids; see <i>Technical Information</i> in the rear of this manual for recommended fluids.• Use only non-acid bath fluids.
	<p>WARNING:</p> <ul style="list-style-type: none">• Always connect the power cord on this Circulator to a grounded (3-prong) power outlet. Make certain that the outlet is the same voltage and frequency as your unit.• Never operate the Circulator with a damaged power cord.• Always turn the Circulator OFF and disconnect mains power before performing any maintenance or service.
	<p>WARNING:</p> <ul style="list-style-type: none">• Never operate the Circulator without bath fluid in the reservoir. Periodically check the reservoir to ensure that the liquid depth is within acceptable levels. Always refill the reservoir using the same bath fluid that is already in the reservoir. Bath oil must not contain any water contaminants and should be preheated to the actual bath temperature before adding as there is an explosion hazard at high temperatures.• Always drain all fluid from the reservoir before moving or lifting your Circulator. Be sure to follow your organization's procedures and practices regarding the safe lifting and relocation of heavy objects.
	<p>WARNING:</p> <ul style="list-style-type: none">• Always allow the bath fluid to cool to ambient temperature before draining.• The reservoir cover, top deck, and/or external pump connections may become hot with continuous use. Exercise caution when touching these parts.
	<p>WARNING: It is the user's responsibility to properly decontaminate the unit in the event hazardous materials are spilled on exterior or interior surfaces. Consult manufacturer if there is any doubt regarding the compatibility of decontamination or cleaning agents.</p>

Regulatory Compliance and Testing

This equipment is compliant with the European Directive 2002/95/EC and its latest amendments on Restrictions on Hazardous Substances (RoHS) and below the given limits of hazardous substances.

ETL Intertek (60 Hz units)

UL 61010-1 / CSA C22.2 No. 61010-1 — Safety Requirements for Measurement, Control, and Laboratory Use; Part 1: General Requirements

UL 61010A-2-010 / CSA C22.2 No. 61010-2-010:04 — Safety Requirements for Measurement, Control, and Laboratory Use; Part 2-010: Particular Requirements for Laboratory Equipment for the Heating of Materials

UL 61010A-2-051 / CSA C22.2 No. 61010-2-051:04 — Safety Requirements for Measurement, Control, and Laboratory Use; Part 2-051: Particular Requirements for Laboratory Equipment for the Mixing and Stirring

CE (all units)

EC Low Voltage Directive 2006/95/EC

EC Electromagnetic Compatibility Directive 2004/108/EC

IEC 61010-1-2001

IEC 61010-2-2001

IEC 61326:2005 / EN 61326 : 2006

Unpacking Your Circulator

Your Circulator is packed in a special carton or cartons. You should keep the packaging, along with all packing materials, until the unit has been installed and you are certain it is working properly.



CAUTION: Remove any loose packing material that may have fallen into the heater/pump housing during shipping. Before powering up, check that nothing remains around the heater or Circulator pump.

We recommend that you begin using your Circulator immediately to confirm proper operation, since beyond one week you may be eligible for warranty repair only (rather than replacement). You'll find complete warranty information in the back of this manual.

In the unlikely event that the unit was damaged or does not operate properly, immediately contact the transportation company, file a damage claim, and contact the company where your Circulator was purchased.

Package Contents

The items included with your Circulator will vary depending on which model Circulating Bath you purchased.

	Heating Only Circulators			Refrigerating / Heating Circulators		
	TC-150MX	TC-250MX	TC-450MX	TC-550MX	TC-650MX	TC-950MX
Resource Disk (with Operator's Manual)	PS110-817					
Fitting Kit for External Applications *	PS510-737					
Bypass Tubing with Spring and Insulation	PS510-713					
Latex Tubing (6-ft., 0.25" ID)	EX-Tubing (Maximum temperature 80°C) **					
Beaker Platform(s) for Bath Reservoir 600 mL 1000 mL	PS703-038	PS703-038 PS703-039		PS703-038	PS703-038	
Rack for Bloom Jars			PS540-563			
Deck Lid(s)	PS510-781	PS510-781 PS510-782 PS510-783		PS510-784	PS510-784	PS510-811
Gabled Reservoir Cover			PS540-562			
IEC Power Cord	1					
Certificate of Compliance	1					
Quick-Start Guide	1					

*. Includes two each: ½" barb x 3/8" barb glass-filled nylon fitting; ½" barb x 5/16" barb glass-filled nylon fitting; ½" barb x ¼" barb glass-filled nylon fitting; ½" ID x 2" black silicone tubing; tube clamp for 5/8" tubing; tube clamp for 7/8" tubing.

** . For higher temperatures, use part number ULA-45A

Controls and Components

MX Controller

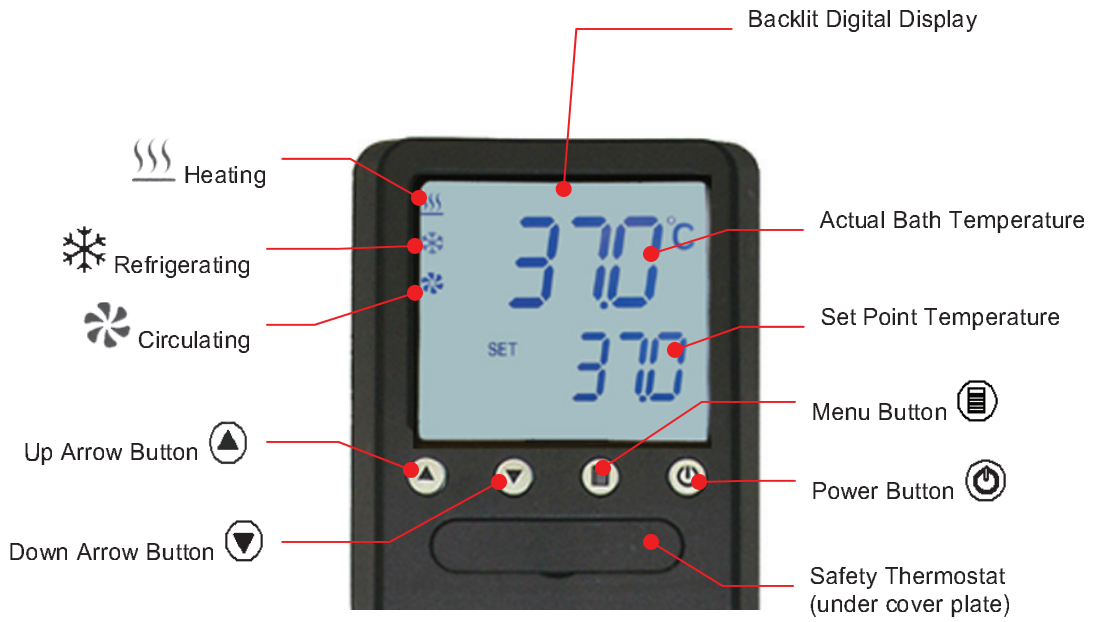

Refrigerating/Heating Baths

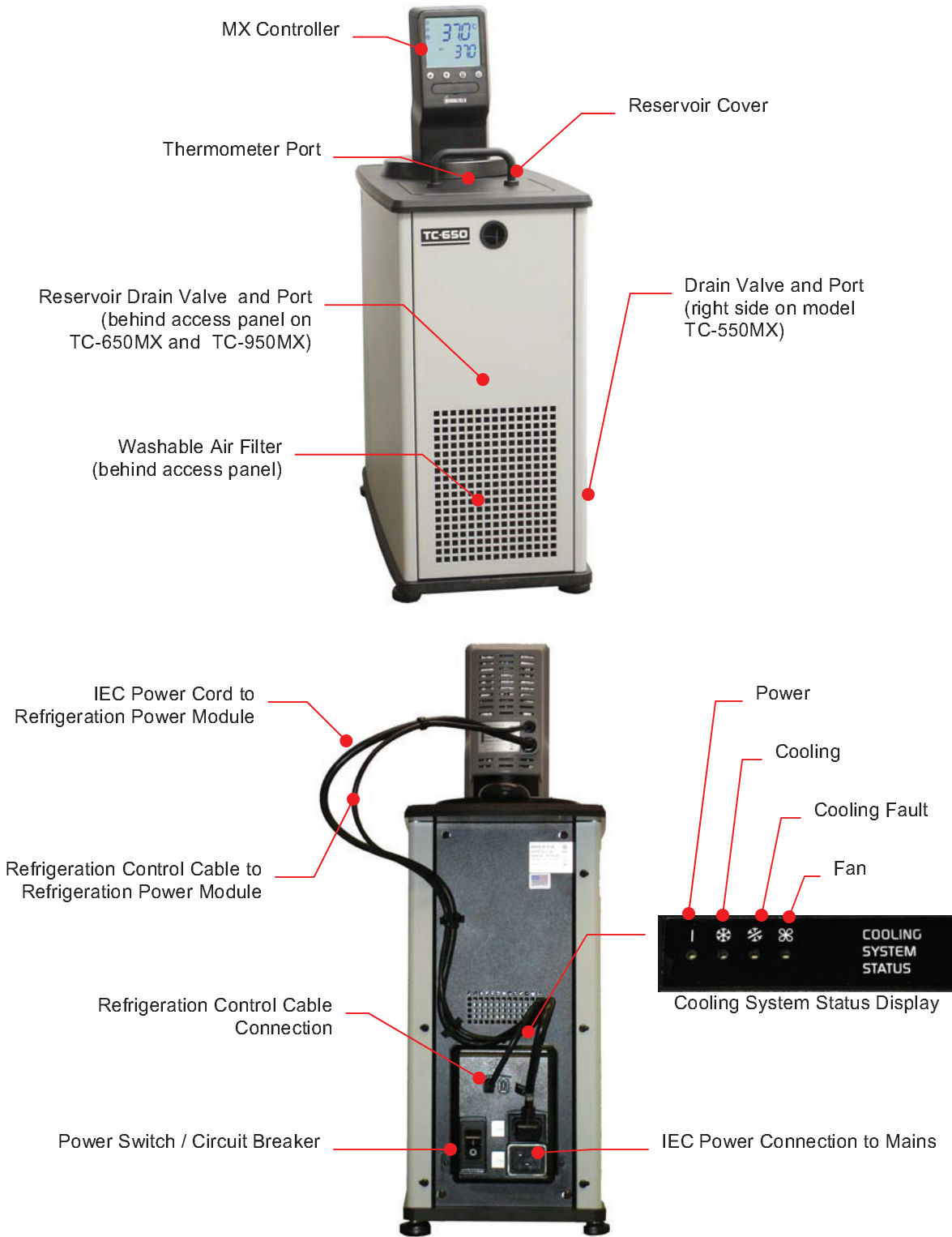

Heating Circulators

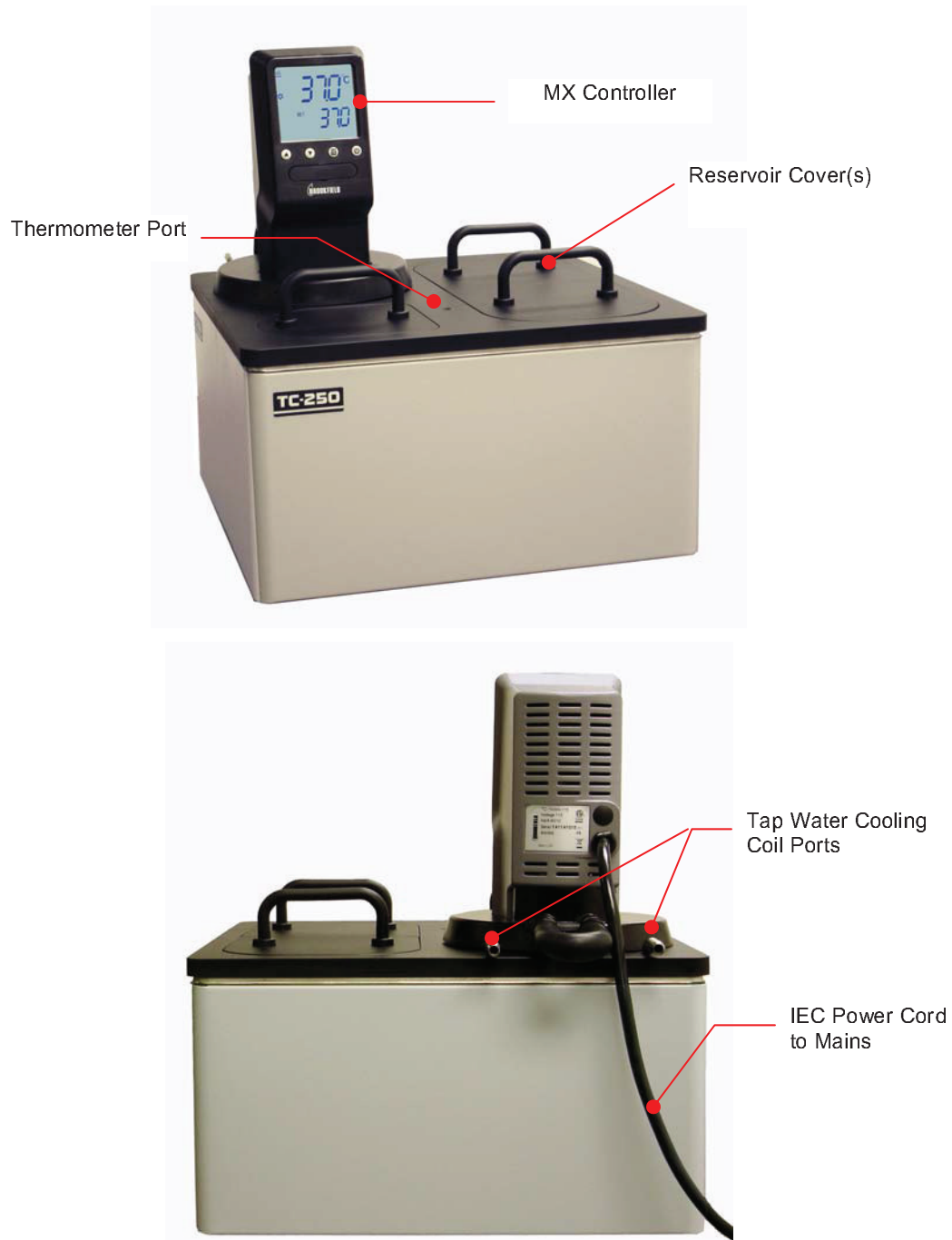

WARNING: Do not lift bath by grasping the Temperature Controller or top deck. Always disconnect electrical power and drain fluid from bath before moving.



WARNING: To avoid the potential for burns, allow the Circulator to cool completely before cleaning or performing any maintenance.

Quick-Start

Unless otherwise specified, quick-start instructions apply to all models.

See Installation & Startup for additional information.

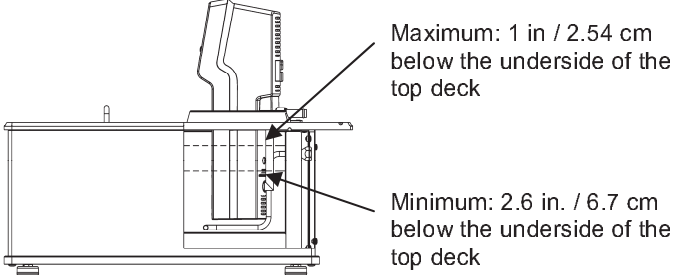
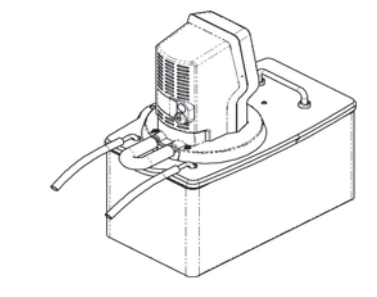
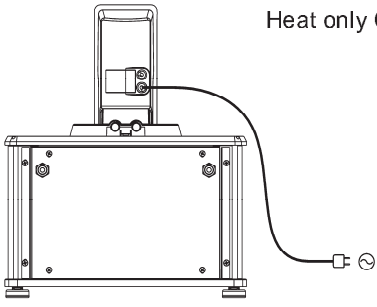
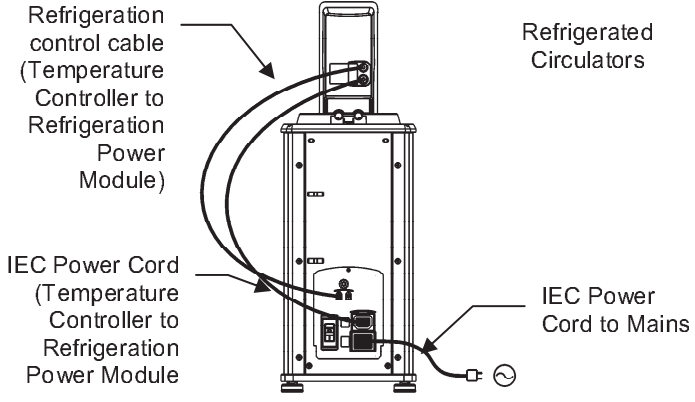
<p>1</p>	<p>Fill reservoir with fluid</p>	
<p>2</p>	<p>Models TC-150 and TC-250: Connect cooling coils to external water line (Use of cooling coils is optional)</p>	
<p>3</p>	<p>Connect all power cords and control cables</p>	<div style="display: flex; flex-direction: column;"> <div style="text-align: right; margin-bottom: 10px;">Heat only Circulators</div>  <div style="text-align: right; margin-bottom: 10px;">Refrigerated Circulators</div>  </div>

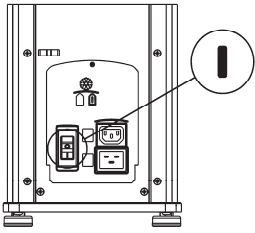
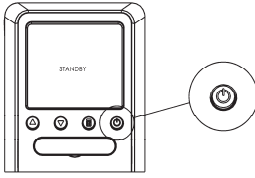
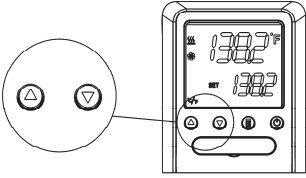
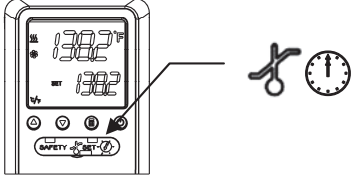
<p>4</p>	<p>Turn Power Switch / Circuit Breaker ON (Refrigerating/Heating Baths only)</p>	
<p>5</p>	<p>Turn Controller ON</p>	
<p>6</p>	<p>Enter temperature set point</p>	
<p>7</p>	<p>Set safety thermostat once unit reaches set point (See <i>Installation and Startup, Controller Setup</i> for details)</p>	

Installation and Startup

Your Circulating Bath with MX Temperature Controller is designed to be simple to set-up and install. The only tools required are a flat-head screwdriver and a container for adding water or another suitable fluid to the bath reservoir.

General Site Requirements

Locate your Circulator on a level surface free from drafts and direct sunlight. Do not place it where there are corrosive fumes, excessive moisture, high room temperatures, or in excessively dusty areas.

Refrigerating / Heating Circulators must be 10.2 cm / 4 inches or more away from walls or vertical surfaces so that airflow is not restricted.

Avoid voltage drops by using properly grounded power outlets wired with 14 gauge or larger diameter wire and if possible, be close to the power distribution panel. The use of extension cords is not recommended; this will reduce the potential for problems caused by low line voltage.

Adding Liquid to the Bath Reservoir

	<p>WARNING: Read the safety data sheet for the bath fluid being used carefully before filling reservoir.</p> <p>WARNING: See Technical Information in the rear of this manual for a list of compatible liquids.</p> <p>WARNING: If the proper fluid level is not maintained, the heater coil may become exposed and possibly damaged (fluid level too low) or the bath may overflow (fluid level too high).</p>
-----------------------------------------------------------------------------------	--------------------------------------------------------------------------------------------------------------------------------------------------------------------------------------------------------------------------------------------------------------------------------------------------------------------------------------------------------------------------------------------------------------------------------------

The liquid in the reservoir should be maintained at a depth between 1 inch / 2.54 cm and 2.6 inches / 6.7 cm below the underside of the bath's top deck. Upon start up, it may be necessary to add fluid to the bath to compensate for the fluid required for external circulation. Likewise, be sure to compensate for fluid displacement when placing samples or other materials in the Circulator's reservoir. See *Technical Information, Reservoir Fluids*.

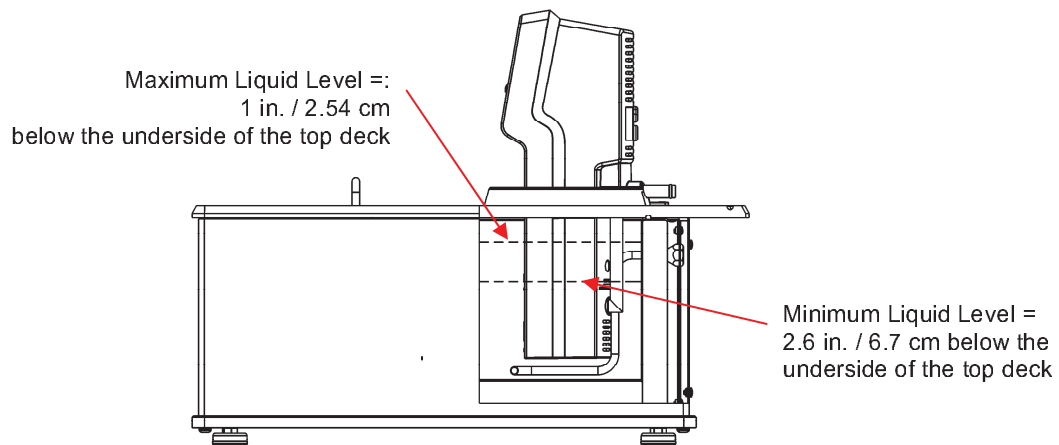

	<p>WARNING: Always drain all fluid from the reservoir before moving or lifting your Circulator. Be sure to follow your organization's procedures and practices regarding the safe lifting and relocation of heavy objects.</p>
-------------------------------------------------------------------------------------	---------------------------------------------------------------------------------------------------------------------------------------------------------------------------------------------------------------------------------------

	<p>WARNING: To avoid the potential for burns, allow the Circulator to cool completely before cleaning or performing any maintenance.</p>
-------------------------------------------------------------------------------------	-------------------------------------------------------------------------------------------------------------------------------------------------

External Closed Loop Circulation

	<p>WARNING: When connecting tubing to an external application, it is the user's responsibility to make sure that the tubing and fittings connected to the Circulator are suitable for the fluid being used and the temperature range of operation.</p> <p>CAUTION: The Circulator's bypass tubing is secured to the fluid inlet and outlet connections by high temperature nylon hose clamps, which can be removed by carefully cutting them with diagonal cutters.</p> <p>CAUTION: Secure the tubing to the inlet and outlet fittings using hose clamps with a minimum ID of 7/8 inch (22 mm). Do not operate the unit without hose clamps.</p>
-----------------------------------------------------------------------------------	-----------------------------------------------------------------------------------------------------------------------------------------------------------------------------------------------------------------------------------------------------------------------------------------------------------------------------------------------------------------------------------------------------------------------------------------------------------------------------------------------------------------------------------------------------------------------------------------------------------------------------------------------------------------------

	<p>WARNING: If the Circulating Bath will not be used for external circulation, the inlet and outlet ports should remain connected using the Buna N bypass tubing provided with the unit.</p>
-----------------------------------------------------------------------------------	-----------------------------------------------------------------------------------------------------------------------------------------------------------------------------------------------------

The single speed pump on your Circulating Bath permits closed loop circulation to a Viscometer accessory, such as the Brookfield Small Sample Adapter, via the 1/2 inch / 12.7 mm OD pump inlet and outlet ports on the rear of the MX Controller. Use the fitting/adaptor kit provided with the unit to make external connections:

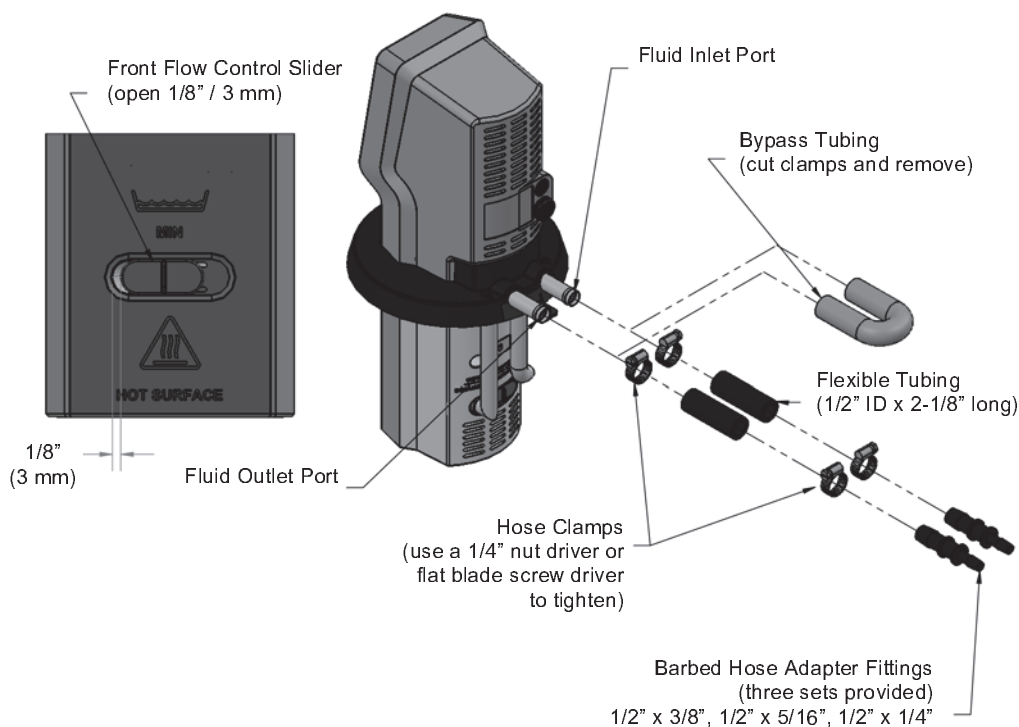

APPLICATION NOTES:

To maintain adequate flow, avoid restrictions in the tubing.

When using the bath for external circulation the front Flow Control Slider must be open one click to the right.

The control stability of a closed loop system is better at the Viscometer accessory than in the immediate vicinity of the heater (provided the accessory control point represents a constant load and is well insulated). For example, if you circulate through a Viscometer at 50°C, the temperature variation observed in the reservoir may be ±0.1°C, whereas in the viscometer it may be only ±0.05°C.

Although stability is better at the Viscometer accessory control point, depending on the insulation and length of tubing used, the accuracy of temperature may be slightly different than the temperature indicated in the reservoir.

**Differences in elevation between the circulator and external device will reduce flow rate.

Connection to external devices which utilize a Quick Connect Coupling, such as R/S Series Rheometer, is not recommended due to potential reduction in flow rate of circulating fluid, which may ultimately affect temperature stability at the external device.

Refrigeration Control Connections (Refrigerating/Heating Circulators only)

Attach the refrigeration control cable connected to the rear of the Temperature Controller to the refrigeration control connection on the Refrigeration Power Module.

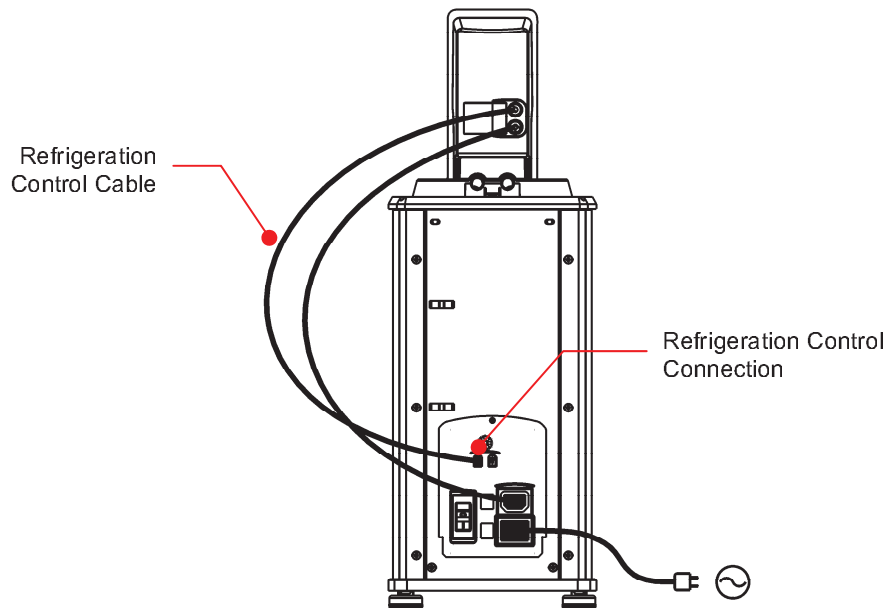

Electrical Power

	WARNING: The Circulator's power cord must be connected to a properly grounded electrical receptacle. Make certain that this electrical outlet is the same voltage and frequency as your Circulator. The correct voltage and frequency for your Circulator are indicated on the identification label on the back of the Controller.
-----------------------------------------------------------------------------------	-------------------------------------------------------------------------------------------------------------------------------------------------------------------------------------------------------------------------------------------------------------------------------------------------------------------------------------------

	CAUTION: The use of an extension cord is not recommended. If one is necessary, it must be properly grounded and capable of handling the total wattage of the unit. The extension cord must not cause more than a 10% drop in voltage to the unit.
-----------------------------------------------------------------------------------	----------------------------------------------------------------------------------------------------------------------------------------------------------------------------------------------------------------------------------------------------------

Refrigerating / Heating Circulators

Attach the Temperature Controller's power cord to the female IEC connector on the Refrigeration Power Module.

Attach the 6-ft / 1.8 m power cord to the IEC electrical connection on the Refrigeration Power Module and then plug the male connector into the Mains electrical outlet.

Place the Power Switch / Circuit Breaker on the Refrigeration Power Module in the ON position. The LCD on the Controller will light and "Standby" will appear on the display.

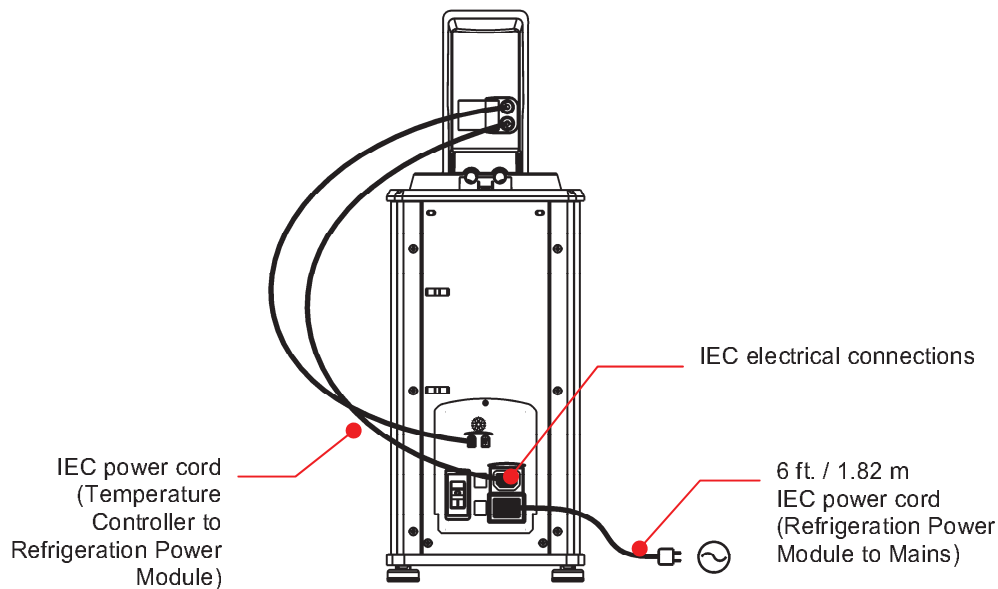

All Other Circulators

Plug the male connector on the Temperature Controller's power cord into the Mains electrical outlet. The LCD on the Controller will light and "Standby" will appear on the display.

	NOTE: 50 Hz models supplied with a country specific electrical cord and plug.
-------------------------------------------------------------------------------------	--------------------------------------------------------------------------------------

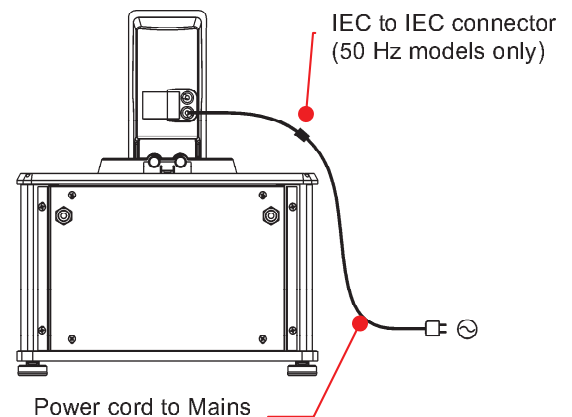

Controller Setup



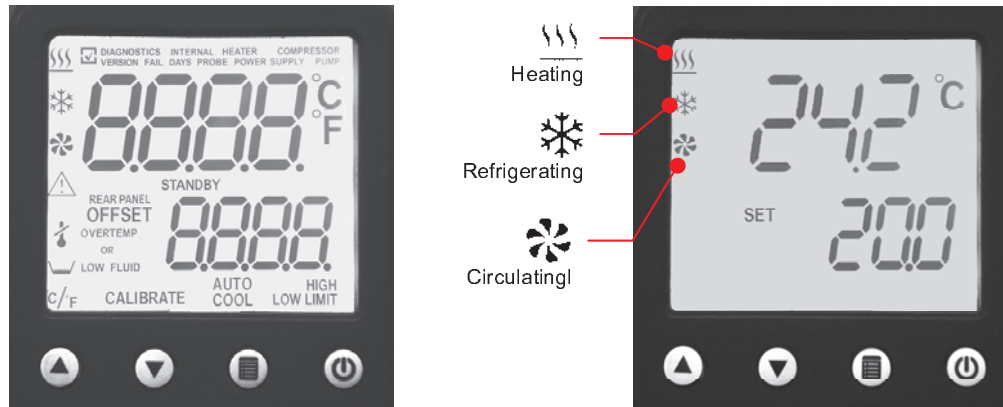

Power

Press ; all characters and symbols on the LCD will momentarily light. The Circulator will begin running, actual and set point temperatures will be displayed, and the word “SET” will be continuously lit. The circulating symbol will also be lit and the heating or refrigerating symbol may be lit or flashing.



Safety Set Temperature

This is a “Do Not Exceed” temperature setting for your Circulator and is the temperature at which the heater will be turned OFF should the liquid level in the bath drop too low or the Circulator malfunctions. It is normally set about 5° higher than the desired operating temperature. Setting the Safety Set temperature is a four-step process.

1. Using a flat blade screwdriver, rotate the Safety Thermostat (located beneath the cover plate) clockwise until it stops.
2. Press the  or  key; “SET” will begin flashing. Continue pressing the  and  keys until the set point temperature is equal to your desired Safety Set temperature. “SET” will stop flashing approximately 10 seconds after the desired temperature has been entered. Allow the Circulator to stabilize at this temperature.
3. Once the bath temperature has stabilized, slowly rotate the Safety Thermostat counter-clockwise until you hear a soft “click;” the OVERTEMP or LOW FLUID alarm symbol will appear on the display approximately 5-10 seconds later. At this point, the heater will also turn OFF.
4. Slowly rotate the Safety Thermostat clockwise until the alarm symbol extinguishes (you may also feel a soft “click”). The heater should turn back ON. You are now ready to start normal operation.







OVERTEMP / LOW FLUID Alarm



WARNING: The Safety Thermostat is user-adjustable from approximately 40° to 155°C. Do not force the indicator dial beyond the stops at either end of the dial's range.

Normal Operation

Keys and Controls

Power		Turns the Circulator's Temperature Controller ON.
Menu		Accesses the Temperature Controller's set-up sub-menus. The items in these sub-menus are used to configure the Controller's general operational parameters (temperature unit, upper and lower temperature limits, offset calibration, etc.).
Up Arrow		Used to increase temperature set point and other operational settings/values.
Down Arrow		Used to decrease temperature set point and other operational settings/values.

Turning Your Circulator ON

Press the  key.

All characters/symbols on the LCD will momentarily light. When the Circulator begins running, the actual and set point temperatures will be displayed and the circulating symbol will be lit.



If the actual bath temperature is lower than the set point temperature, the heating symbol will also be lit.











Refrigerating/Heating Models: If the actual bath temperature is higher than the set point temperature, the refrigerating symbol will be lit. It is normal for both the heating and refrigerating symbols to be lit simultaneously when nearing or maintaining the set point temperature.

Main Operational Display



Set-Up Sub-Menus

Press the  key to access the Temperature Controller's set-up sub-menus. The  or  keys are used to change the current setting / value in the sub-menu.





Sub-Menu	Selection / Range	To Change Current Value
Temperature unit	°C or °F	Press  for °C Press  for °F
Offset Calibration	-3.0°C to +3.0°C	Press  or 
Low Limit	-35° to +10°C / -30° to +50°F	Press  or 
High Limit	+40° to +140°C / +100 to +285°F	Press  or 
Auto Cool	1° to 135°C / 34° to 275°F (TC-950MX) 1° to 70°C / 34° to 158°F (TC-550MX, TC-650MX)	Press  or 

To accept a value in a sub-menu, press  or allow the display to 'time out' (approximately 10 seconds).

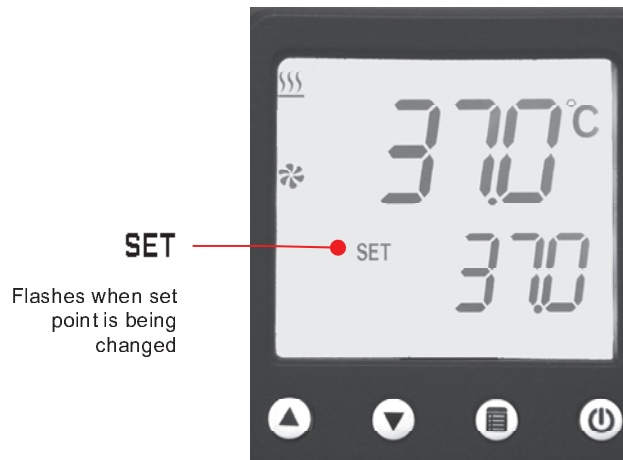
Adjusting the Temperature Set Point

This is the temperature at which the fluid in your Circulating Bath will be maintained. It may be set to one-tenth of a degree over a range of -30.0° to +135.0°C / -20.0° to +275.0°F. The factory default set point is +20.0°C / +68.0°F.





To Change: Press the  or  key. The word "SET" will begin flashing. Continue holding or repeatedly press  or  until the desired set point temperature is displayed.

To Accept: Press  or allow the LCD to return to the main operational display (approximately 10 seconds).

Selecting the Temperature Unit

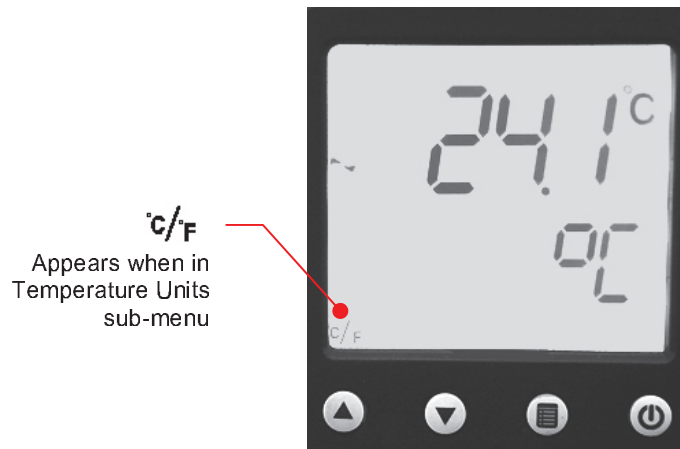
The temperature units sub-menu (°C / °F) allows you to select the temperature unit in which the actual bath temperature and set point temperature are displayed. The factory default is °C.











To Access: Press the  key until °C/°F appears on the display.

To Change: Press  to select °C; press  to select °F.

To Accept: Press  or allow the LCD to return to the main operational display (approximately 10 seconds).

Setting the Offset Calibration

This sub-menu allows you to match the Circulator's temperature display to an external reference thermometer. A value from -3.0° to +3.0°C may be entered; the factory default is 0.0°C.

	<p>IMPORTANT: To prevent the Offset Calibration value from being changed unintentionally, the following power down/power up sequence is required to enable the Offset Calibration function.</p> <p><u>Refrigerating Circulators:</u></p> <ol style="list-style-type: none">1. Place the power switch/circuit breaker on the rear of the unit in the OFF position.2. Return the power switch/circuit breaker to the ON position while pressing and holding the  key.3. When STANDBY appears on the display, release the  key and press . You can now proceed as outlined below. <p><u>Heat Only Circulators:</u></p> <ol style="list-style-type: none">1. Remove the power cord from the electrical outlet.2. Plug the power cord back into the electrical outlet while pressing and holding the  key.3. When STANDBY appears on the display, release the  key and press . You can now proceed as outlined below. <p>The Offset Calibration function will remain enabled until the electrical power is turned OFF by pressing the  key.</p>
-----------------------------------------------------------------------------------	------------------------------------------------------------------------------------------------------------------------------------------------------------------------------------------------------------------------------------------------------------------------------------------------------------------------------------------------------------------------------------------------------------------------------------------------------------------------------------------------------------------------------------------------------------------------------------------------------------------------------------------------------------------------------------------------------------------------------------------------------------------------------------------------------------------------------------------------------------------------------------------------------------------------------------------------------------------------------------------------------------------------------------------------------------------------------------------------------------------------------------------------------------------------------------------------------------------------------------------------------------------------------------------------------------------------------------------------------------------------------------------------------------------------------------------------------------------------------------------------------------------------------------------------------------------------------------------------------------------------------------------------------------------------------------------------------------------

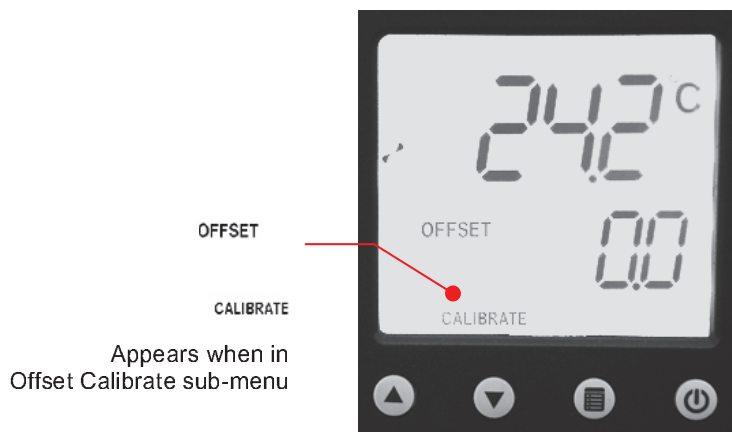

To Access: Press the  key until OFFSET CALIBRATE appears on the display.

To Change: Press  or .

To Accept: Press  or allow the LCD to return to the main operational display (approximately 10 seconds).

	<p>CAUTION: The Offset Calibration value is always shown in degrees C, even if degrees F is selected as the temperature unit in which the control and actual bath temperatures are displayed. Your Circulator will automatically convert the °C offset calibration value to the correct °F display offset value.</p>
-------------------------------------------------------------------------------------	-----------------------------------------------------------------------------------------------------------------------------------------------------------------------------------------------------------------------------------------------------------------------------------------------------------------------------

Setting the Low Limit Temperature

This sub-menu allows you to limit how low the temperature set point may be set. It also serves as a low limit safety, alerting you if bath temperature falls below the low limit temperature setting. The Low Limit value may be set from -35° to $+10^{\circ}\text{C}$ / -30° to $+50^{\circ}\text{F}$; the factory default is -35°C / -30°F .

To avoid unwanted alarms or shutdowns during regular operation, the Low Limit value should be set at least 5° lower than the selected control temperature.

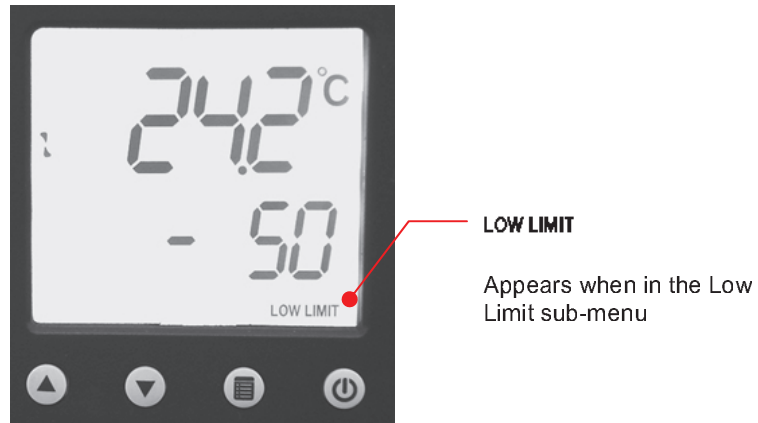

To Access: Press the  key until LOW LIMIT appears on the display.

To Change: Press  or .

To Accept: Press  or allow the LCD to return to the main operational display (approximately 10 seconds).

Setting the High Limit Temperature

This sub-menu allows you to limit how high the temperature set point may be set. It also serves as a high limit safety, alerting you if bath temperature rises above the high limit temperature setting. The High Limit value may be set from +40° to +140°C / +100° to +285°F; the factory default is +140°C / +285°F.

To avoid unwanted alarms or shutdowns during regular operation, the High Limit value should be set at least 5° higher than the selected control temperature.

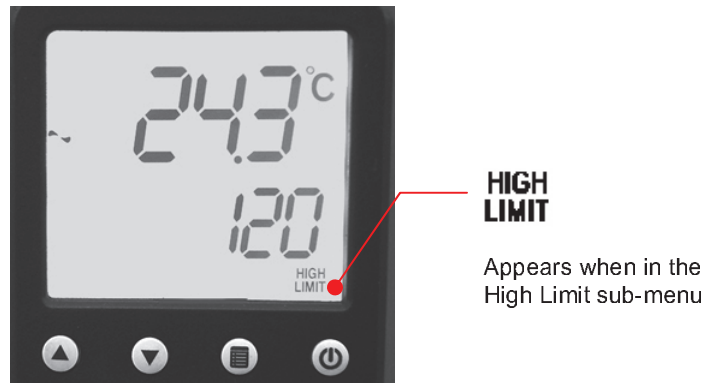

To Access: Press the  key until HIGH LIMIT appears on the display.

To Change: Press  or .

To Accept: Press  or allow the LCD to return to the main operational display (approximately 10 seconds).

Adjusting the Auto Cool Temperature

This sub-menu is displayed only on Refrigerating / Heating Circulators. It determines the bath temperature at which refrigeration will be activated and permits more precise control when operating at high temperatures as well as more rapid cool downs. For most applications, an Auto Cool set point 15°C above room temperature is recommended. The Auto Cool range is from 1° to 135°C. The factory default is 45°C.

Cool Command™ Refrigeration — The TC-950MX features the Cool Command™ modulating refrigeration control system. Cool Command™ allows the refrigeration system to turn on at a fluid temperature up to 135°C when the temperature set point is changed to or below the Auto Cool set point (135°C maximum). As a result, bath fluid cools more quickly.

Conventional Refrigeration — TC-550MX and TC-650MX Refrigerating/Heating Circulators use a conventional refrigeration system. The refrigeration system will turn on when the bath temperature and set point are below the Auto Cool set point (70°C maximum).

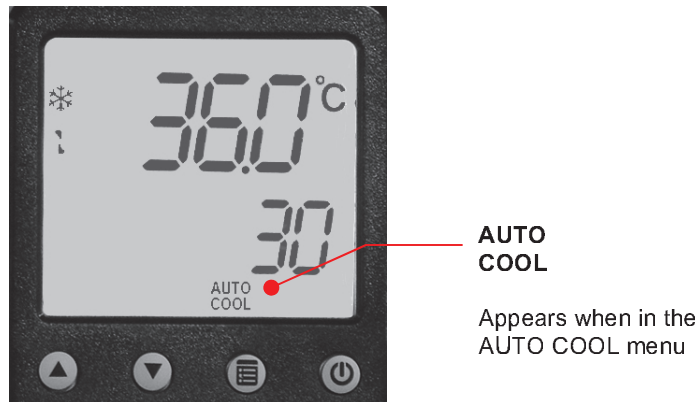



To Access: This Press the  key until AUTO COOL appears on the display.

To Change: Press  or .

To Accept: Press  or allow the LCD to return to the main operational display (approximately 10 seconds).

Resetting the Factory Default Values

You can return your Circulator to all factory-set defaults as follows:

1. Press the  key to turn the Circulator OFF.
2. Turn Mains power OFF by unplugging the power cord from the electrical outlet or (Refrigerating/Heating Circulators) placing the power switch/circuit breaker on the Refrigeration Power Module in the OFF position.
3. Turn Mains power ON while pressing the  button.

The factory default values are:

Operational Parameter	Factory Default Value
Temperature Scale	°C
Temperature Set Point	20°C / 68°F
Calibration Offset	0.0°C
Low Limit	-35°C / -30°F
High Limit	140°C / 285°F
Auto Cool	45°C

Loss of Power Restart

	WARNING: The unit will start automatically after a disruption in electrical power.
-------------------------------------------------------------------------------------	-------------------------------------------------------------------------------------------





In the event that electrical power is lost while your Circulator is in use, it will begin operating automatically once power is restored. FAIL POWER will appear on the display to alert you that there was a power disruption. To clear the message, turn the Circulator OFF and then back ON again using the  key.





FAIL POWER

Indicates electrical power was disrupted during operation

Display Messages and Alarms

Alarm Symbol	Description	Corrective Action
FAIL POWER	Informational Message: Indicates that electrical power was lost during operation.	Using the  key, turn the Circulator OFF and then back ON. This will clear the message.
LOW LIMIT (flashing)	Warning: The temperature set point is below the Low Limit temperature value.	Decrease the Low Limit temperature value or increase the temperature set point.
HIGH LIMIT (flashing)	Warning: The temperature set point is above the High Limit temperature value.	Increase the High Limit temperature value or decrease the set point temperature.
 LOW LIMIT	Alarm: The bath temperature has fallen below the Low Limit temperature value. Power to the compressor and pump will remain OFF until the problem is corrected.	Allow bath to warm or add heat load. Decrease the Low Limit temperature value.
 HIGH LIMIT	Alarm: The bath temperature has risen above the High Limit temperature value. Power to the heater and pump will remain OFF until the problem is corrected.	Allow bath to cool or increase High Limit temperature value.
 OVERTEMP OR  LOW FLUID	Fault: The liquid in the bath has dropped too low or the temperature of the bath fluid has exceeded the Safety Set temperature. Power to the heater will remain OFF until the problem is corrected.	Fluid level in reservoir has fallen below minimum level; add fluid as required. Fluid temperature is higher than Safety Set temperature; increase Safety Set temperature setting. Controller failure; consult factory.
INTERNAL FAIL PROBE	Fault: The Circulator's temperature sensor has failed.	Consult factory.
FAIL HEATER	Fault: The Circulator's heater has failed.	Consult factory.

Routine Maintenance and Troubleshooting

	WARNING: Always turn your Circulating Bath OFF and disconnect it from the electrical power outlet before performing any maintenance or service.
	WARNING: To avoid the potential for burns, allow the Circulating Bath to cool completely before cleaning or performing any maintenance.
	WARNING: Always drain all fluid from the reservoir before moving or lifting your Circulator. Be sure to follow your organization's procedures and practices regarding the safe lifting and relocation of heavy objects.

Maintaining Clear Bath Water

Optimum temperature and moisture conditions for algae growth exist when using water as a bath fluid. To prevent algae contamination and minimize the frequency of draining the reservoir, an algaecide such as TC-Fluid 1A should be used.

	WARNING: Do not use chlorine bleach.
------------------------------------------------------------------------------------	---------------------------------------------

Draining the Bath Reservoir

	WARNING: Bath fluids should be stored and disposed of according to applicable laws and regulations.
-------------------------------------------------------------------------------------	------------------------------------------------------------------------------------------------------------

Refrigerated / Heating Circulating Baths

Refrigerated / Heating Circulating Baths are equipped with a drain valve and port located either behind the front access panel or on the right hand side of the unit.

To drain fluid from the bath, attach a short length of suitable 11.5 mm ID / 0.45 inch ID tubing to the drain port and secure it using a hose clamp with a minimum ID of 18 mm / 0.7 inch. Open the drain valve using a flat blade screwdriver. When closing the valve, do not over tighten.

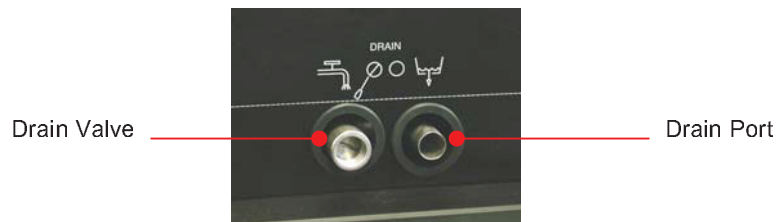

	WARNING: Be sure to close the drain valve before refilling the bath reservoir. Do not over tighten.
-------------------------------------------------------------------------------------	------------------------------------------------------------------------------------------------------------

Checking the Over-Temperature Safety System

Your Circulator incorporates over-temperature protection according to IEC 61010. For optimum safety, this system should be checked for proper operation at least every six months. This check must be performed with the unit running.

1. Enter a temperature set point of approximately 50°C and then allow the bath to stabilize at that temperature. The amount of time this will take will depend on the size of the bath and the difference between the initial bath temperature and the Safety Set temperature.
2. Once the bath temperature has stabilized, slowly rotate the Safety Thermostat counter-clockwise until you feel a soft “click;” the OVERTEMP or LOW FLUID alarm symbol will appear on the display approximately 5-10 seconds later. At this point, the heater will also turn OFF.
3. Slowly rotate the Safety Thermostat clockwise until the alarm symbol extinguishes (you may also feel a soft “click”). The heater should turn back ON.
4. Reset the Safety Set temperature to the desired temperature value (see *Controller Setup, Safety Set Temperature*).



Cleaning Your Circulator



WARNING: It is the user's responsibility to properly decontaminate the unit in the event hazardous materials are spilled on exterior or interior surfaces. Consult the manufacturer if there is any doubt regarding the compatibility of decontamination or cleaning agents.

Temperature Controller

Turn the Temperature Controller OFF by pressing  and unplug power cord from the electrical outlet.

Wipe the housing with a clean cloth dampened with a mild detergent and water or mild all-purpose cleaner.



CAUTION: Do not spray cleaning liquids directly onto the Temperature Controller or allow them to enter the Controller's vents. Do not use abrasives as these could scratch the housing or the digital display.

Bath Reservoir



CAUTION: Do not use steel wool to clean your Circulator's bath reservoir.

Bath Reservoir and Wetted Components — A concentrated bath cleaner (TC-Fluid 6A) is available to remove mineral deposits from the stainless steel reservoir and the Temperature Controller's wetted parts. The cleaner should be added to the bath reservoir at the prescribed dosage and circulated at 60°C / 140°F until the scale is removed.

External Surfaces — Only mild detergents and water or an approved cleaner should be used on the top deck and other external surfaces of your Circulator.

Pump Impeller — In the unlikely event that debris becomes lodged in the pump impeller, a soft brush can be used to remove any lodged particles. If necessary, soak in a solution of distilled water and bath cleaner (TC-Fluid 6A) to soften before brushing.



CAUTION: Do not use hard utensils or abrasive pads to remove trapped debris.

Condenser, Air Vents, and Reusable Filter (Refrigerated Models only)

To keep the refrigeration system operating at optimum cooling capacity, the condenser, removable air filter, and all air vents (front, side, back) should be kept free of dust and dirt. Be sure to check them on a regular basis and clean as required.

The reusable filter is easily accessed from the front of the unit by simply removing the access panel. Use a mild detergent and water solution to wash off any accumulated dust and dirt. Rinse and dry thoroughly before reinstalling.

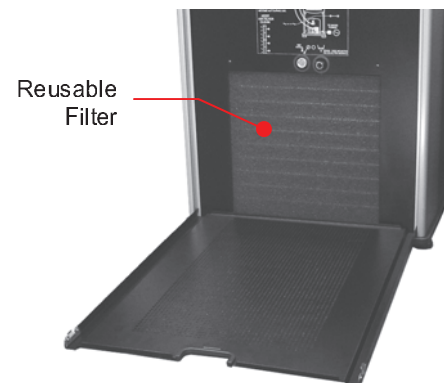

Temperature Controller Removal and Re-Installation

Removal

The Temperature Controller on your Circulating Bath is designed to be easily removed from the top deck without the use of special tools. It is removed as follows:

1. Place the tip of a small flat blade screwdriver under the retaining ring locking tab and pry up gently.

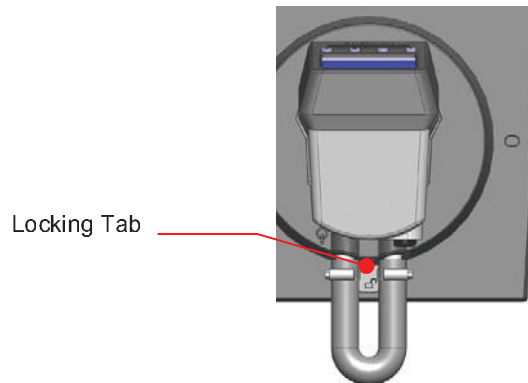

2. Rotate the Temperature Controller clockwise until it stops (about 0.75 inch / 1.9 cm).

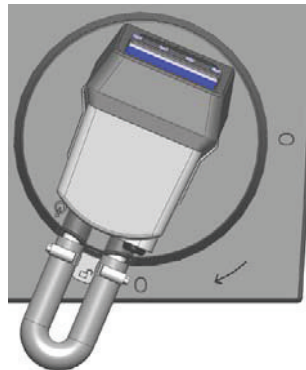

3. Lift the Controller straight up and out of the opening of the Circulator's top deck.

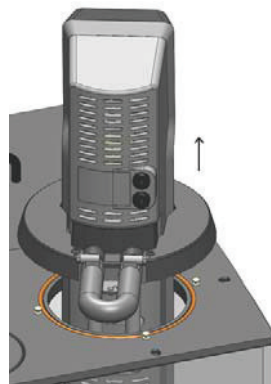

Re-Installation

The top deck of your Circulator incorporates four alignment pins to facilitate positioning of the Temperature Controller when it is being reinstalled. These pins correspond to keyhole slots on the interior of the Circulator's retaining ring. It also incorporated two indents which can accept the locking tab. These indents are located 90° from one another, allowing you to position the Temperature Controller at either of two different viewing angles.

1. With the retaining ring locking tab oriented above one of the indents on the top deck, slowly lower the Temperature Controller into the top deck opening until it is resting on top of the positioning pins.

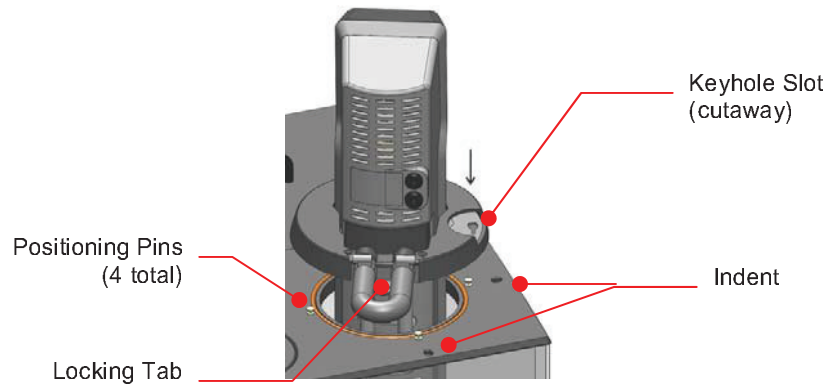

2. Gently rotate the Temperature Controller until it drops down on the Positioning Pins.

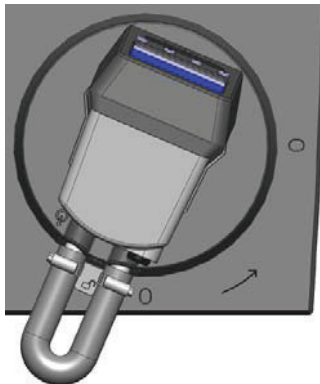

3. Rotate the Temperature Controller counterclockwise until the Locking Tab engages the indent on the top deck.

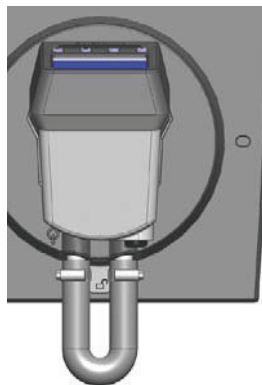

Troubleshooting Chart

Problem	Possible Causes	Corrective Action
Unit does not run (Digital Display is blank)	No power to unit <i>Refrigerated units only</i> Electrical cord between Control Head and Refrigeration Power Module loose or unplugged Power Switch / Circuit Breaker in OFF position	Check that the electrical cord is secure and connected to an operating electrical outlet. Check that the electrical cord is secure and properly connected. Place Power Switch / Circuit Breaker in ON position.
Unit does not run (STANDBY appears on Digital Display)	Unit in Standby mode	Press Power Key on front panel.
No fluid circulation	Insufficient fluid in reservoir Pump impeller jammed	Add fluid to reservoir. Inspect pump and remove debris as required.
Insufficient circulation	Fluid viscosity too high External tubing diameter too small Low line voltage	Replace with lower viscosity bath fluid. Replace with larger diameter tubing. Check and correct as required.
Unit does not heat	Insufficient fluid in reservoir Temperature set point too low Safety Set Temperature too low	Add fluid to reservoir. Increase temperature set point. Increase Safety Set temperature.
Insufficient heating	Insufficient circulation Low line voltage Ambient temperature too cool Excessive heat loss	See Insufficient circulation, above. Check and correct as required. Increase ambient temperature or relocate unit. Check for heat loss from external tanks and hoses; Check for vapor/heat loss from internal reservoir.
Temperature unstable	Insufficient circulation Debris or mineral build-up on pump, heater, or temperature sensor.	Check pump flow and operation. Clean as required.
Unit does not cool	Dust build up on air filter or condenser Blocked air ventilation screens Temperature set point is too high Excessive heat load Ambient air temperature too high (>35°C / 95°F) Low or high line voltage	Clean air filter and/or condenser as required. Remove blockages as required. Decrease temperature set point. Check that heat load does not exceed capacity of bath; correct as required. Decrease ambient air temperature. Check and correct as required.

Problem	Possible Causes	Corrective Action
Insufficient cooling	Dust build up on air filter or condenser Blocked air ventilation screens Temperature set point is too high Excessive heat load Ambient air temperature too high (>35°C / 95°F) Low or high line voltage	Clean air filter and/or condenser as required. Remove blockages as required. Decrease temperature set point. Check that heat load does not exceed capacity of bath; correct as required. Decrease ambient air temperature. Check and correct as required.
Unable to achieve low end extreme temperatures	Pump speed too high Incorrect bath fluid Insufficient insulation on external fluid lines Ambient air temperature too high (>35°C / 95°F) Low or high line voltage Dust build up on air filter or condenser Blocked air ventilation screens Excessive heat load	Reduce pump speed. Check that the fluid being circulated is capable of reaching the required temperature. Check external fluid lines for proper insulation. Decrease ambient air temperature as required. Check and correct as required. Clean air filter or condenser as required. Remove blockages as required. Check that heat load does not exceed capacity of bath; correct as required.

Technical Information

Reservoir Fluids

Depending on your needs, a variety of fluids can be used with your Circulator. No matter what bath fluid is selected, it must be chemically compatible with the reservoir and the materials in your Circulator. It must also be suitable for the desired temperature range.

	WARNING: Do not use a flammable liquid as a bath fluid as a fire hazard may result.
-----------------------------------------------------------------------------------	--------------------------------------------------------------------------------------------

	WARNING: Always use fluids that satisfy safety, health, and equipment compatibility requirements.
-----------------------------------------------------------------------------------	----------------------------------------------------------------------------------------------------------

For optimum temperature stability, the fluid's viscosity should be 50 centistokes (cSt) or less at its lowest operating temperature. This permits good fluid circulation and minimizes heating from the pump.

For temperatures from 10°C to 90°C, distilled water is recommended. For temperatures below 10°C, a mixture of laboratory grade ethylene glycol and water should be used. Do not use deionized water.

The following chart is intended to serve as a guide in selecting a bath fluid for your application. For optimum temperature stability and low vaporization, be sure to stay within the fluid's normal temperature range.

You are responsible for proper selection and use of the fluids. Avoid extreme range operation.

Fluid Description	Viscosity (cSt) @ 25°C	Specific Heat			Normal Temperature Range	Extreme Temperature Range
		@ Fluid Temperature	BTU/lb°F	KJ/Kg°C		
distilled water	1	50°C	1.00	4.18	10° to 90°C	2° to 100°C
TC-Fluid 3	50	100°C	0.41	1.71	50° to 150°C	5° to 270°C*
TC-Fluid 4	125	150°C	0.40	1.67	100° to 200°C	80° to 232°C*
TC-Fluid 5	3	-30°C	0.62	2.59	-50° to 100°C	-62° to 118°C
TC-Fluid 2	20	-20°C	0.78	3.26	-25° to 100°C	-30° to 115°C

	*WARNING: This is the fluid's flash point temperature.
-------------------------------------------------------------------------------------	---------------------------------------------------------------

	<p>WARNING: DO NOT USE THE FOLLOWING LIQUIDS:</p> <ul style="list-style-type: none">• Automotive antifreeze with additives**• Hard tap water**• Deionized water with a specific resistance > 1 meg ohm• Any flammable fluids• Concentrations of acids or bases• Solutions with halides: chlorides, fluorides, bromides, iodides or sulfur• Bleach (Sodium Hypochlorite)• Solutions with chromates or chromium salts• Glycerine• Syltherm fluids <p>** At temperatures above 40°C, additives or mineral deposits can adhere to the heater. If deposits are allowed to build up, the heater may overheat and fail. Higher temperatures and higher concentrations of additives will hasten deposit build up.</p>
-----------------------------------------------------------------------------------	------------------------------------------------------------------------------------------------------------------------------------------------------------------------------------------------------------------------------------------------------------------------------------------------------------------------------------------------------------------------------------------------------------------------------------------------------------------------------------------------------------------------------------------------------------------------------------------------------------------------------------------------------------------------------------------------------------------------------------------------------------------------------------------------------------------------

Application Notes

At a fluid's low temperature extreme:

- The presence of ice or slush adversely affects temperature stability.
- A viscosity above 10 centistokes adversely affects temperature uniformity.
- A high fluid viscosity and high pump speed adds heat to the fluid being pumped.

At a fluid's temperature above ambient without refrigeration:

- If your set point temperature is less than 15°C above the ambient temperature, the viscosity of the fluid should be 10 centistokes or less to minimize friction heating of the fluid.
- Heat loss should be encouraged by uncovering the fluid and lowering the pump speed.

At fluid's high temperature extreme:

- Heat loss from vapor adversely affects temperature stability.
- To prevent the accumulation of vapors inside the room, the reservoir may need to be placed in a fume hood.
- Use a cover and/or floating hollow balls to help prevent heat and vapor loss.
- Replenish fluid lost from vapor frequently.

Equipment Disposal (WEEE Directive)

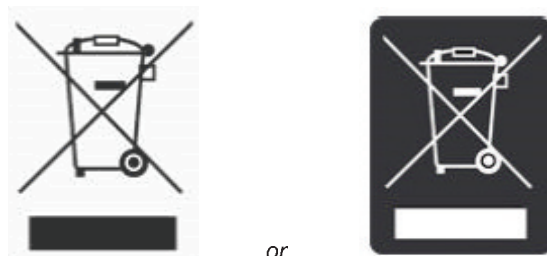

This equipment is marked with the crossed out wheeled bin symbol to indicate it is covered by the Waste Electrical and Electronic Equipment (WEEE) Directive and is not to be disposed of as unsorted municipal waste. **Any products marked with this symbol must be collected separately, according to the regulatory guidelines in your area.**

It is your responsibility to correctly dispose of this equipment at lifecycle-end by handing it over to an authorized facility for separate collection and recycling. It is also your responsibility to decontaminate the equipment in case of biological, chemical and/or radiological contamination, so as to protect the persons involved in the disposal and recycling of the equipment from health hazards. By doing so, you will help to conserve natural and environmental resources and you will ensure that your equipment is recycled in a manner that protects human health.

Requirements for waste collection, reuse, recycling, and recovery programs vary by regulatory authority at your location. Contact your local responsible body (e.g., your laboratory manager) or authorized representative for information regarding applicable disposal regulations.

Replacement Parts. Optional Accessories & Fluids

Replacement Parts, MX Controller	Part Number BEL
Bypass Tubing Kit. Short hose with internal spring connecting the inlet and outlet ports of the circulator.	PS510-713
Barbed Hose Kit (MX). Multiple sized barbed hose adapters with connection sleeves and clamps.	PS510-737
Beaker Platform, small. 1.5" height	PS703-038
Beaker Platform, large. 0.75"-1.5" height for use with TC-250 bath	PS703-039
Deck Lid Cover, TC-150. Flat iron opening (5.03" x 4.27")	PS510-781
Deck Lid Covers, TC-250. Split cover male (5.69" x 5.565")	PS510-782
Deck Lid Covers, TC-250. Split cover female (5.94" x 5.565")	PS510-783
Deck Lid Covers, TC-250. Flat iron opening (5.03" x 4.27")	PS510-781
Deck Lid Cover, TC-550 and TC-650	PS510-784
Deck Lid Cover, TC-950	PS510-811
Resource Disk. Includes all literature and manuals.	PS110-817
Reusable Air Filter, TC-550	PS305-057
Reusable Air Filter, TC-650	PS305-054
Reusable Air Filter, TC-950	PS305-055
O-Ring for Drain Valve, TC-550 and TC-650 baths	PS400-934
Accessory connection Hose, rated for -50° to +80°C	EX-Tubing
Refrigeration Control Cable. TC-550, TC-650, and TC-950	PS525-879
Resource Disk (with Operator's Manual)	PS110-817
Optional Accessories	
Ball Valve to control external circulator flow	SB-21
Insulated Tubing, rated for -40° to +120°C	TC-Tubing
High Temperature Fluoran Tubing Kit, rated for -40° to +200°C	ULA-45A
Beaker Cover. Stainless steel split beaker cover with openings for spindle, guard leg, and temperature probe.	PB-1Y
Fluids	
Algaecide, 8 oz.	TC-Fluid 1A
50/50 premix Ethylene Glycol and distilled water, 1 gallon (-20° to +100°C)	TC-Fluid 2
High Temperature Fluid (50° to 150°C). 1 gallon	TC-Fluid 3
High Temperature Fluid (100° to 200°C). 1 gallon	TC-Fluid 4
Low Temperature Fluid (-50° to +100°C). 1 gallon	TC-Fluid 5
Bath Cleaner, 8 oz.	TC-Fluid 6A

Warranty Repair and Service

Brookfield TC-Series Circulating Temperature Baths are guaranteed for two years from date of purchase against defects in materials and workmanship. The temperature baths must be returned to **Brookfield Engineering Laboratories, Inc.** or to the Brookfield dealer from whom it was purchased for warranty service. Transportation is at the purchaser's expense.

When returning to Brookfield in the USA, please contact us for a Return Goods authorization number and shipping instructions; failure to do so may result in a longer repair time.

For repair or service in the **United States** contact:

Brookfield Engineering Laboratories, Inc.
11 Commerce Boulevard
Middleboro, MA 02346 U.S.A.
Telephone: (508) 946-6200 FAX: (508) 923-5009
www.brookfieldengineering.com

For repair or service outside the United States, consult Brookfield Engineering Laboratories, Inc. or the dealer from whom you purchased the instrument.

For repair or service in the **United Kingdom**:

Brookfield Viscometers Limited
Brookfield Technical Centre
Stadium Way
Harlow, Essex CM19 5GX, England
Telephone: (44) 1279/451774 FAX: (44) 1279/451775
www.brookfield.co.uk

For repair or service in **Germany**:

Brookfield Engineering Laboratories Vertriebs GmbH
Hauptstrasse 18
D-73547 Lorch, Germany
Telephone: (49) 7172/927100 FAX: (49) 7172/927105
www.brookfield-gmbh.de

For repair or service in **China**:

Guangzhou Brookfield Viscometers and Texture Instruments Service Company Ltd.
Suite 905, South Tower, Xindacheng Plaza
193 Guangzhou Da Dao Bei, Yuexiu District
Guangzhou, 510075 P. R. China
Telephone: (86) 20/3760-0548 FAX: (86) 20/3760-0548
www.brookfield.com.cn

Manufactured by:
PolyScience
6600 W. Touhy Avenue Niles, IL 60714 U.S.A.
1-800-229-7569 • 1-847-647-0611
www.polyscience.com